

USER MANUAL



Thank you for choosing Better Bathrooms.
Please read this manual before installing your product
and keep for future reference.

better 
bathrooms

Product

Arisa Mini Cloakroom Basin Mixer Tap - ARIMB001, ARIBB001, ARICH001,
ARIMW009, ARIVRG001

Arisa Mono Basin Mixer Tap - ARIMB002, ARIBB002, ARICH002,
ARIMW001, ARIVRG002

Arisa Mono High Rise Basin Mixer Tap - ARIMB003, ARIBB003, ARICH003

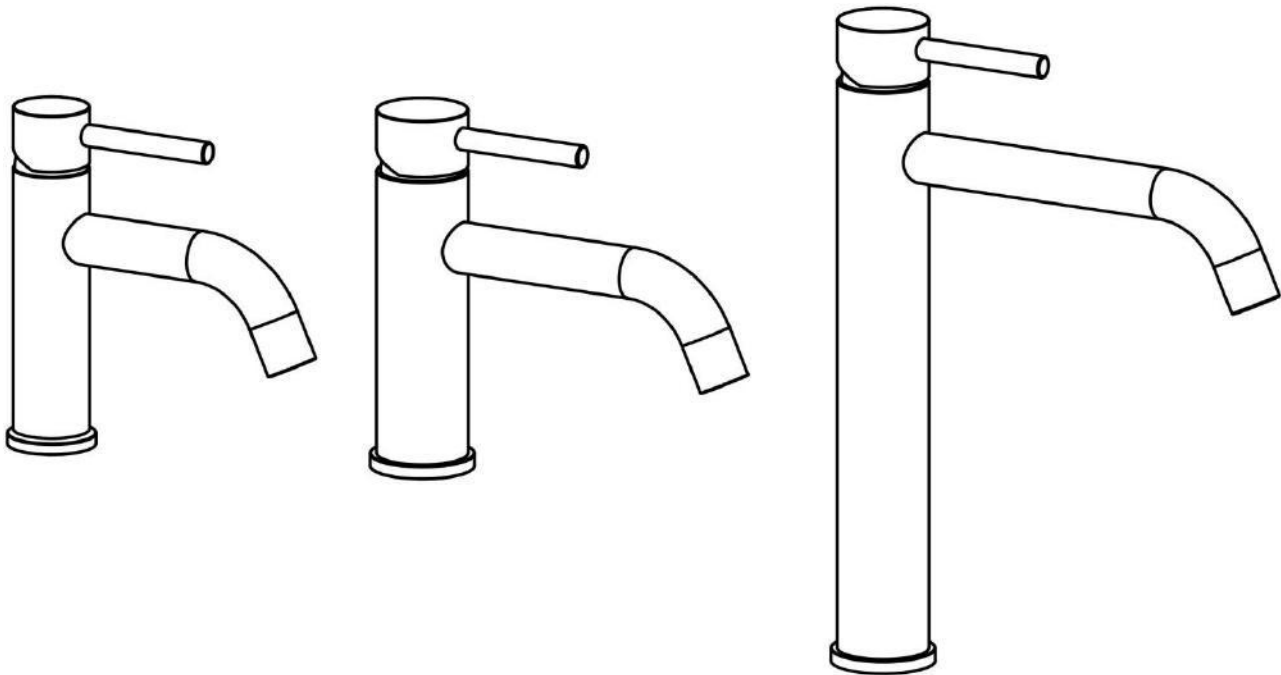

- **Single-person assembly**
- **Tools required**
- **We always recommend using professional tradespeople to install your product**

V4_15/8/2023

Congratulations on your purchase

And welcome to our growing gang of savvy shoppers

We're on a mission to bring you extraordinary bathroom products, for less. From modern to traditional style ceramics, plus the gorgeous fixtures, fittings and furniture to match. So, you can fall in love with your space every single day.

As one of the UK's largest independent bathroom stores, we've received countless awards; including the National Business Awards UK, the Digital Entrepreneur Awards and being placed on The Sunday Times Fast Track 100.

We hope your new product goes above and beyond your expectations. However, should any problems occur, please:

- log in to your account and contact our customer services team via your self-serve portal – betterbathrooms.com/CustomerAccount/Login
- contact us via betterbathrooms.com/content/contact-us

Important information

- Please read these instructions thoroughly and retain for future reference
- Installation must be carried out in compliance with The Water Fittings Regulations and Scottish Water Byelaws.
- The system must be flushed prior to installation
- Minimum and Maximum working pressure : 1 - 5 bar
- Pressures must be equal for optimum performance
- Please do not connect hot and cold water supply lines in reverse. This could result in hot water flowing from cold line and cause scalding.
- The feed-water temperature of water shall not exceed 85°C.
Exceeding 85° may cause scalding, the service life of faucets might be shortened, or the faucet might be damaged.
- After installation, please make sure the faucet is securely mounted and checked for leaks.

Parts / Diagrams

Round Mini Cloakroom Basin Mixer Tap		
	No	Description
	1	Handle assembled
	2	Dome
	3	Locknut
	4	Cartridge
	5	Body assembled
	6	Aerator with housing
	7	Rubber washer
	8	Gasket
	9	Leg
	10	Locknut
	11	Screw
	12	Flexible hose

Round Mono Basin Mixer Tap		
	No	Description
	1	Handle assembled
	2	Dome with locknut
	3	Cartridge
	4	Body assembled
	5	Aerator with housing
	6	Rubber washer
	7	Gasket
	8	Leg
	9	Locknut
	10	Screw
	11	Flexible hose

Round Mono High Rise Basin Mixer Tap

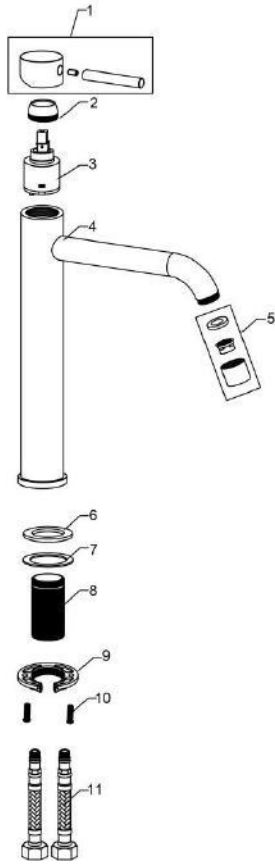

No	Description
1	Handle assembled
2	Dome with locknut
3	Cartridge
4	Body assembled
5	Aerator with housing
6	Rubber washer
7	Gasket
8	Leg
9	Locknut
10	Screw
11	Flexible hose

Dimensions

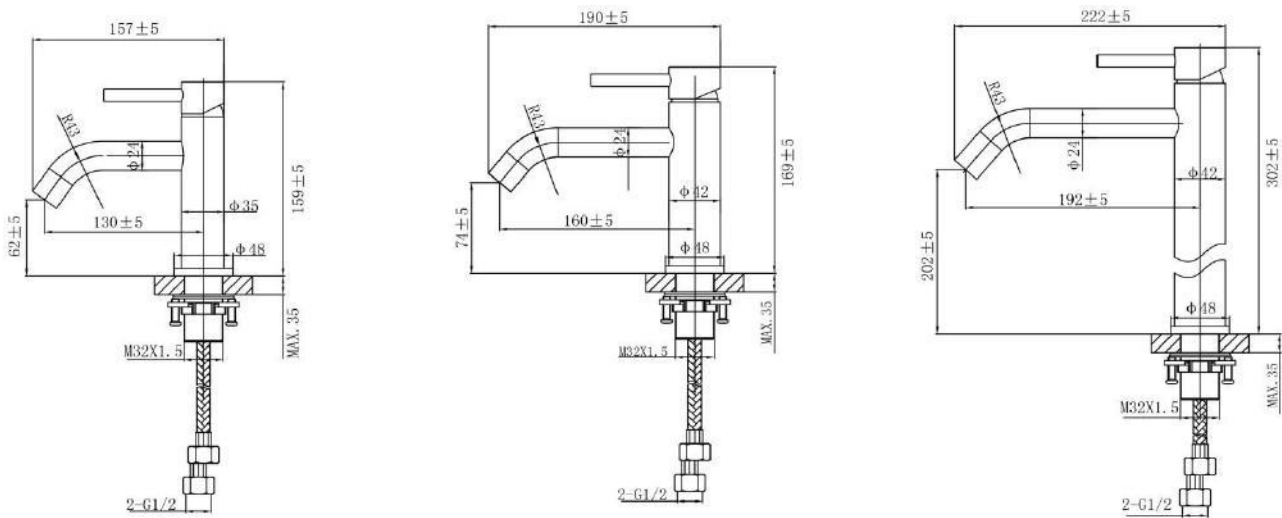

Tools required

- Screwdriver

Installation

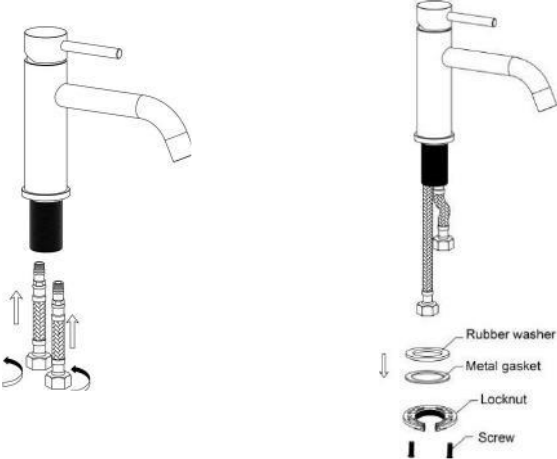
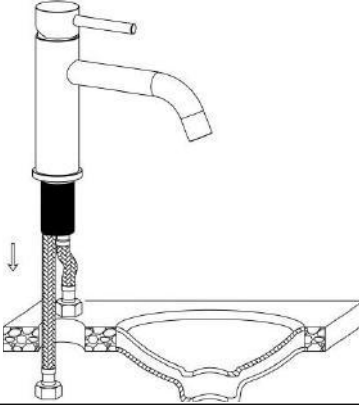
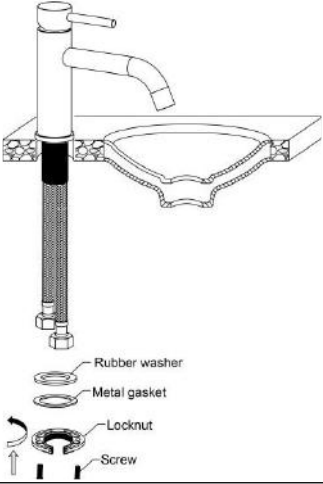
	<p>Install the flexible hoses with inlets in the body (if the hoses were not pre-assembled).</p> <p>Remove the Screws, Locknut, Metal gasket, Rubber Washer from the mixer body .</p> <p>The flexible hoses are pre-assembled with the body from the factory.</p>
	<p>Ensure the o-ring is fitted between the base and basin/top.</p> <p>From above basin, push the inlet hoses through the hole on basin and position correctly.</p> <p>Do not allow the hoses to be kinked or twisted</p>
	<p>From underneath basin, secure mixer body by placing Rubber Washer, Metal gasket onto the leg, followed by fixing Locknut and screws.</p> <p>Tighten the Locknut and screws by screwdriver until mixer is secure, do not overtighten as this could crack the ceramic</p>
<p>Correct installation way</p>	<p>When tightening the locknut, ensure the screws are in the same level.</p> <p>Do not allow the locknut to be installed in inclined state.</p>

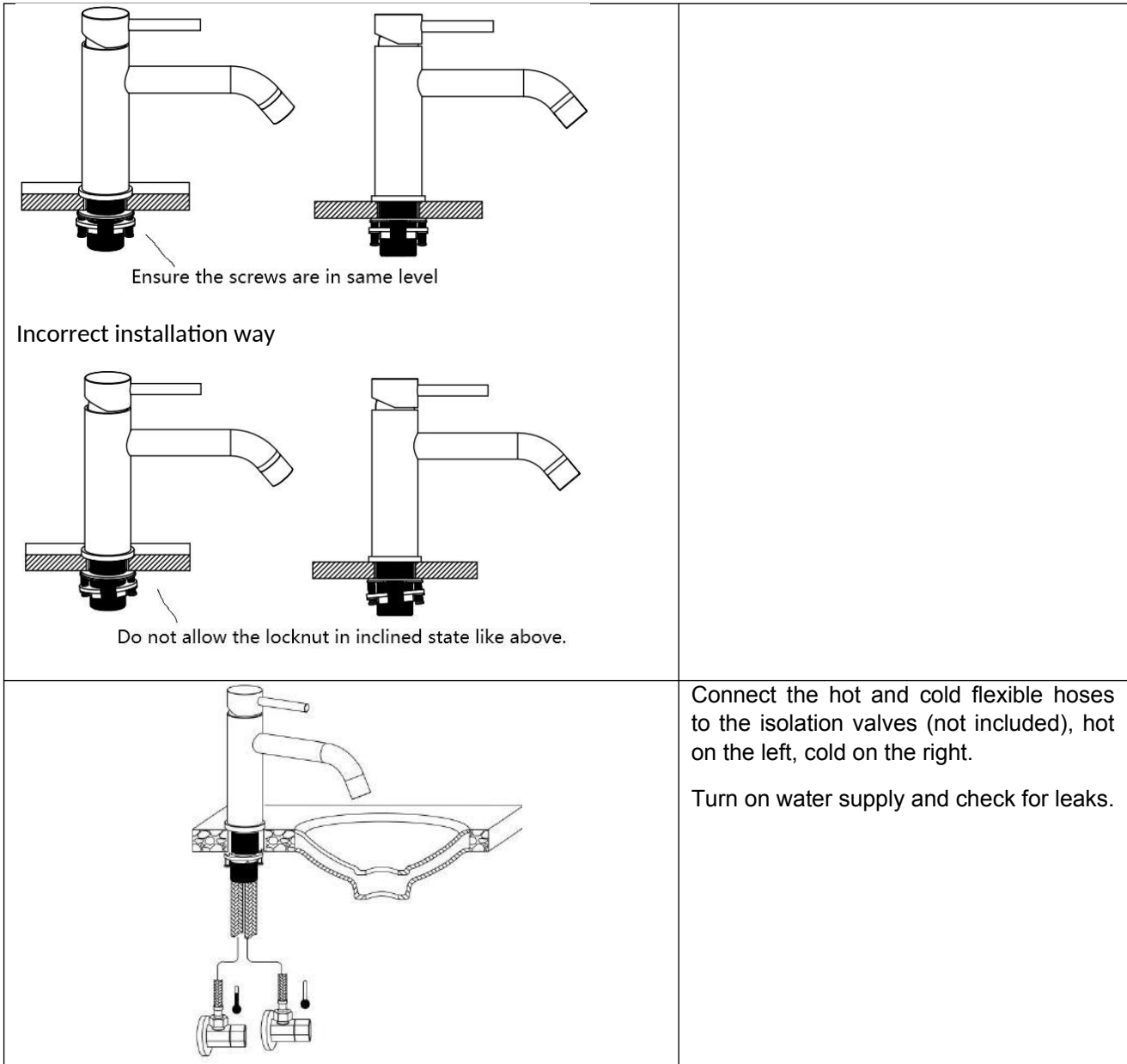

Operation

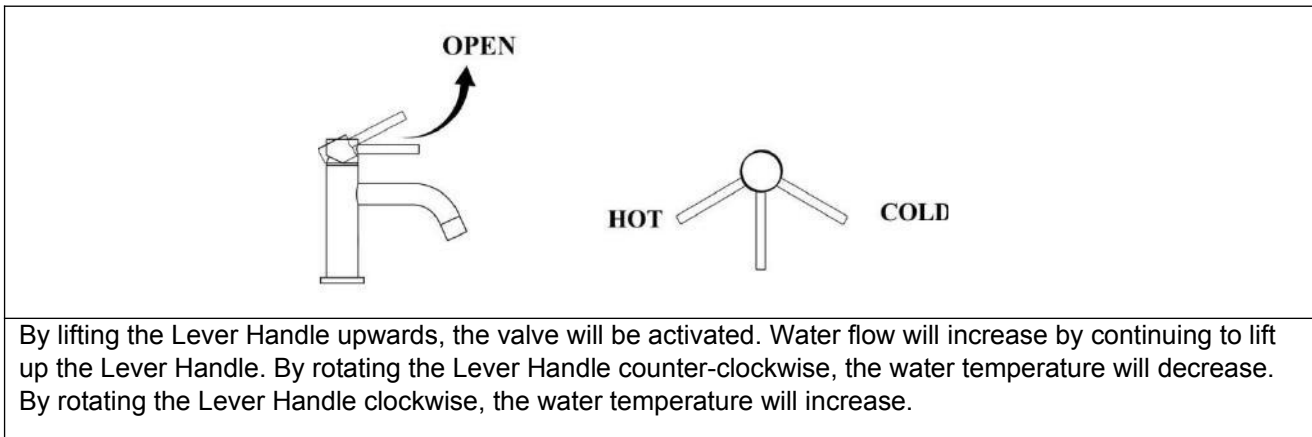



Troubleshooting

Issues	Inspection Item	
	Mini Cloakroom Basin Mixer Tap	Mono Basin Mixer Tap
Poor water flow	<ul style="list-style-type: none"> • Is the mixer cartridge(4) free from debris • Is there blockage within the filter mesh on aerator(6) • Is the flexible hose(12) kinked or twisted • Was the system flushed prior to installation 	<ul style="list-style-type: none"> • Is the mixer cartridge(3) free from debris • Is there blockage within the filter mesh on aerator(5) • Is the flexible hose(11) kinked or twisted • Was the system flushed prior to installation
Water leak	<ul style="list-style-type: none"> • Is the locknut(3) on top of cartridge fully tightened • Is there damage or dirt within the O-rings of the cartridge(4) • Is there damage or dirt with the rubber washer or O-ring of the aerator(6) • Is the housing of aerator(6) fully tighten • Is there damage with the rubber washer(7) • Is there damage within the rubber washer inside the nuts of flexible hoses(12) • Is there damage with the O-rings on the flexible hoses(12) 	<ul style="list-style-type: none"> • Is the locknut(2) on top of cartridge fully tightened • Is there damage or dirt within the O-rings of the cartridge(3) • Is there damage or dirt with the rubber washer or O-ring of the aerator(5) • Is the housing of aerator(5) fully tighten • Is there damage with the rubber washer(6) • Is there damage within the rubber washer inside the nuts of flexible hoses(11) • Is there damage with the O-rings on the flexible hoses(11)
Handle loose	<ul style="list-style-type: none"> • Is the screw inside the handle (1) fully tightened 	<ul style="list-style-type: none"> • Is the screw inside the handle (1) fully tightened
Body loose	<ul style="list-style-type: none"> • Are the locknut(10) and screw(11) underneath fully tightened 	<ul style="list-style-type: none"> • Are the locknut(9) and screw(10) underneath fully tightened

Maintenance

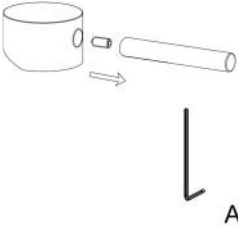
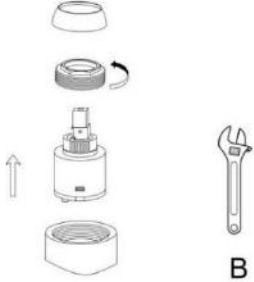
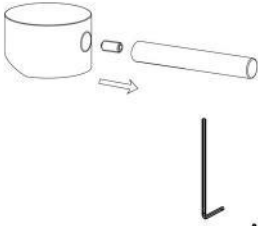
Replacement of Cartridge

 <p>A</p>	 <p>B</p>	<p>Round Mini Cloakroom Basin Mixer Tap</p> <p>A: Uninstall the lever by rotating anti-clockwise. Remove the screw by using allen key. Take out the handle.</p> <p>B: Remove the Cap, locknut (by using wrench), cartridge from the body accordingly to the graph.</p> <p>Install a new cartridge in reverse steps.</p>
 <p>A</p>	 <p>B</p>	<p>Round Mono Basin Mixer Tap</p> <p>A: Uninstall the lever by rotating anti-clockwise. Remove the screw by using allen key. Take out the handle.</p> <p>B: Loosen the Cap with locknut by using a plier to clamp the blocks inside and rotate anti-clockwise, take out the cap and cartridge from the body accordingly to the graph.</p> <p>Install a new cartridge in reverse steps.</p>

Replacement of Aerator

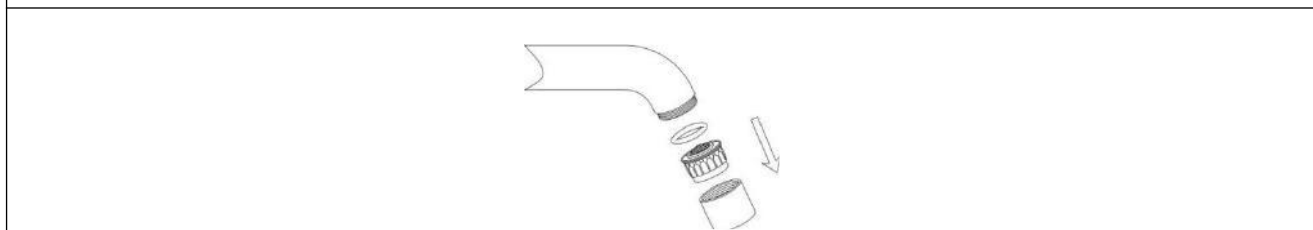

Cleaning

To maintain the surface of your product, wipe with a clean damp cloth and wipe dry, do not use any abrasive cleaning agents or materials. If any harsh chemicals come into contact with the surface of the product, rinse and wipe clean immediately.

For more information

- visit betterbathrooms.com
- email customerservices@buyitdirect.co.uk
- call 03303903062
- write to Trident Business Park, Neptune Way, Huddersfield, HD2 1UA

**better
bathrooms**

Part of the BuyItDirect Group

USER MANUAL



Thank you for choosing Better Bathrooms.
Please read this manual before installing your product
and keep for future reference.

better 
bathrooms

Product

ARIMB020 - Matt Black Round Bottle Trap
ARIBB023 - Brushed Brass Round Bottle Trap
ARIMW008 - Matt White Round Bottle Trap
ARIVRG008 - Vapour Rose Gold Round Bottle Trap

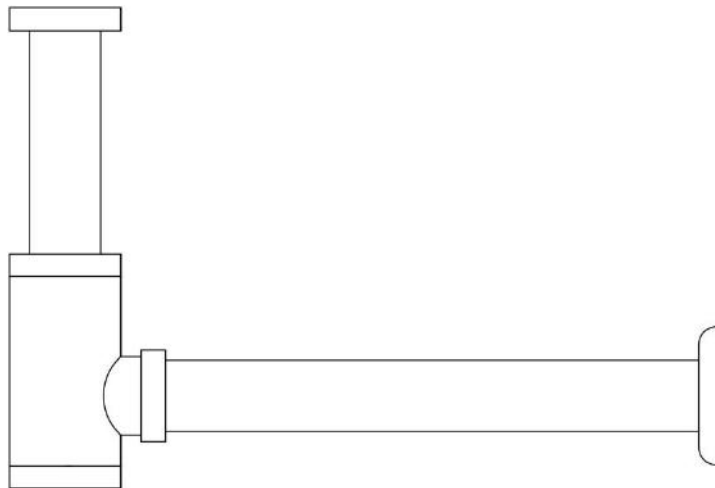

- **Single-person assembly**
- **We always recommend using professional tradespeople to install your product**

V2_3/9/2022

Congratulations on your purchase

And welcome to our growing gang of savvy shoppers

We're on a mission to bring you extraordinary bathroom products, for less. From modern to traditional style ceramics, plus the gorgeous fixtures, fittings and furniture to match. So, you can fall in love with your space every single day.

As one of the UK's largest independent bathroom stores, we've received countless awards; including the National Business Awards UK, the Digital Entrepreneur Awards and being placed on The Sunday Times Fast Track 100.

We hope your new product goes above and beyond your expectations. However, should any problems occur, please:

- log in to your account and contact our customer services team via your self-serve portal – betterbathrooms.com/Account/Login
- contact us via betterbathrooms.com/contact-us

Important information

- Please read these instructions thoroughly and retain for future reference
- Installation must be carried out in compliance with The Water Fittings Regulations and Scottish Water Byelaws.
- The system must be flushed prior to installation, else it might clog the filter and the following phenomenon occurs: discharged water volume is small, or temperature cannot be controlled well.
- Pressures must be equal for optimum performance
- Please do not connect hot and cold water supply lines in reverse. This could result in hot water flowing from cold line and cause scalding.
- The feed-water temperature of water shall not exceed 85°C. Exceeding 85°C may cause scalding, the service life of faucets might be shortened, or the faucet might be damaged.
- After installation, please make sure the faucet is securely mounted and checked for leaks.
-

Parts / Diagrams

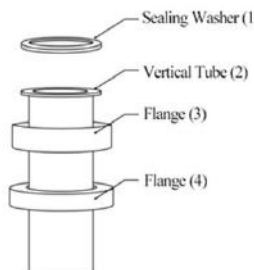
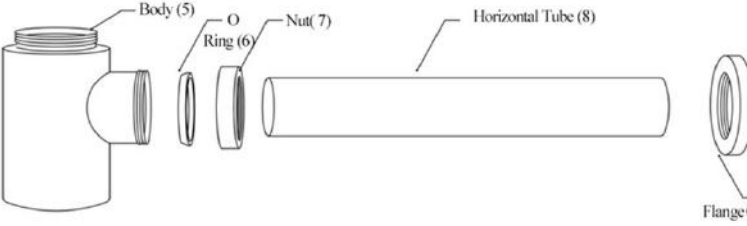
	No	Part Description
	1	Sealing washer
	2	Vertical tube
	3	Flange
	4	Flange
	5	Body
	6	O-ring
	7	Nut
	8	Horizontal tube
	9	Flange

Dimensions

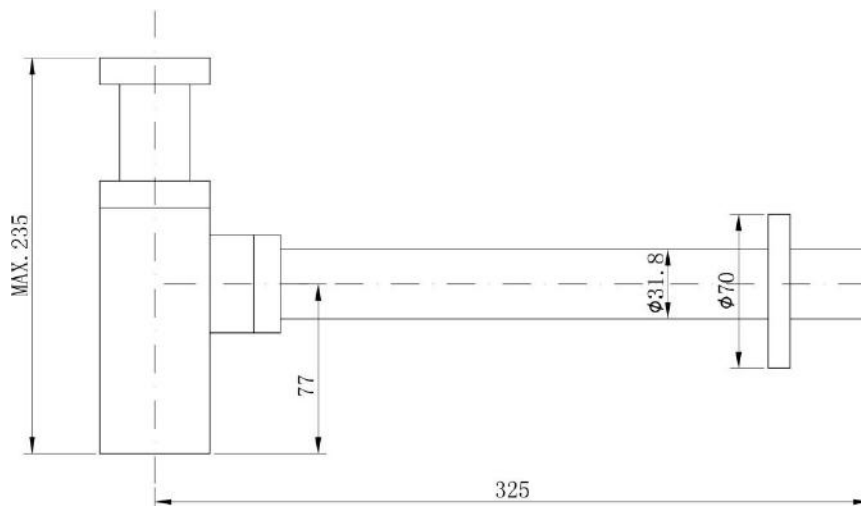

Tools required

- Seal tape

Installation

	<ul style="list-style-type: none"> • Place the horizontal tube(8) through hole in the wall, slide the flange(9) along the tube until they reaches the wall to fit. • Slide the flange(3) along the vertical tube(2) and insert the sealing washer(1). Screw the flange(3) to the bottom of the waste(not supplied). • Slide the vertical tube(2) through the flange(4) and into the bottle trap body(5). Adjust to the required length to connect with the horizontal tube(8) and then fasten the joint with the nut(7) until the position is secured. • Check all the joints for leaks. <p>Note: Ensure the tube must be inserted at least 25mm inside both the outlet of bottle trap and drain stub-out.</p>
--	----------------------------------------------------------------------------------------------------------------------------------------------------------------------------------------------------------------------------------------------------------------------------------------------------------------------------------------------------------------------------------------------------------------------------------------------------------------------------------------------------------------------------------------------------------------------------------------------------------------------------------------------------------------------------------------------------------------------------------------------------------

Troubleshooting

Issues	Check
Water leak	<ul style="list-style-type: none"> • Is there damage with the o-ring(6) • Is the nut(7) fully tighten? • Is there damage with the sealing washer(1)

Maintenance and Cleaning

To maintain the surface of your product, wipe with a clean damp cloth and wipe dry, do not use any abrasive cleaning agents or materials.

If any harsh chemicals come into contact with the surface of the product, rinse and wipe clean immediately.

For more information

- visit betterbathrooms.com
- email customerservices@buyitdirect.co.uk
- call 03303903062
- write to Trident Business Park, Neptune Way, Huddersfield, HD2 1UA

**better
bathrooms**

Part of the BuyItDirect Group